

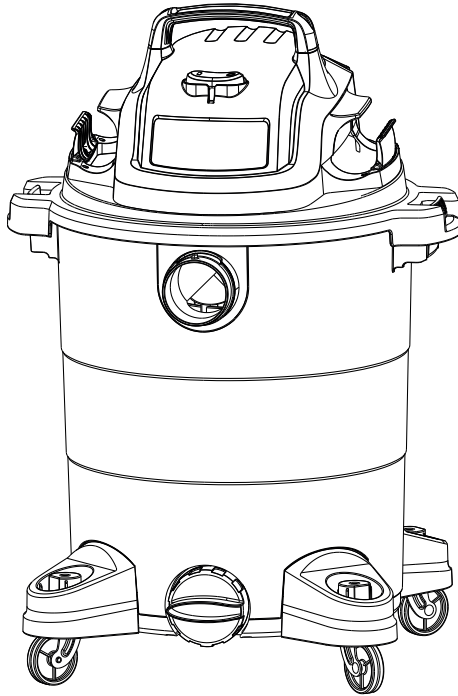

## 8 GALLON WET/DRY VAC



# Operation Manual

MODEL #'s VOC809PF 3801



This safety alert symbol identifies important safety messages in this manual. Failure to follow this important safety information may result in serious injury or death.

# TABLE OF CONTENTS

SECTION	PAGE
Warranty .....	3
Important Safety Instructions .....	4
Double Insulation Instructions .....	6
Extension Cords .....	7
Symbols .....	8
Unpacking & Checking Carton Contents .....	9
General Assembly Instructions .....	10
Dry Vacuum Operation .....	12
Liquid Vacuum Operation .....	14
Blower Operation .....	16
Maintenance .....	17
Installing & Cleaning Cartridge Filter .....	18
Installing & Cleaning Foam Wet Filter .....	19
Troubleshooting .....	20
Exploded View .....	21
Parts List .....	22

**Thank you for purchasing this Black Diamond™ wet/dry vacuum cleaner. Feel confident that with Black Diamond™ you are obtaining a high quality product engineered for optimal performance. This vacuum is capable of picking up liquids and dry materials.**

**FOR YOUR SAFETY: CAREFULLY READ AND UNDERSTAND ALL INSTRUCTIONS.**

We take pride in producing a high quality, durable product. This Black Diamond™ product carries a limited two (2) year warranty against defects in workmanship and materials from date of purchase under normal household use. If product is to be used for commercial, industrial, or rental use, a 90 day limited warranty will apply. Please keep your receipt as proof of purchase. This warranty gives you specific legal rights, and you may have other rights, which vary from state to state. For customer service please call 877-806-9067.

**Not Covered by Warranty:**

- Any part that has become inoperative due to misuse, negligence, direct/indirect abuse, accidents, improper maintenance, repairs, or alterations
- Consumables such as filters and accessories
- Normal wear and tear of parts and attachments, such as hose, nozzles, or casters
- Normal deterioration of the exterior finish due to use or exposure
- Any product where serial number/data label is tampered with or removed
- Any product purchased from an unauthorized retailer

## IMPORTANT SAFETY INSTRUCTIONS

READ AND UNDERSTAND ALL INSTRUCTIONS BEFORE USING THIS VACUUM. Read and understand this operator's manual and all labels on the Wet/Dry Vacuum cleaner before operating. Safety is a combination of common sense, staying alert and knowing how your vacuum works. Use this Wet/Dry Vacuum only as described in this manual. To reduce the risk of personal injury or damage to your Wet/Dry Vacuum, use only manufacturer recommended accessories. For Household Use Only



### **SAVE THIS MANUAL FOR FUTURE REFERENCE.**

**When using a vacuum, basic precautions should always be followed including the following:**



### **WARNING**

#### **TO REDUCE THE RISK OF FIRE, ELECTRIC SHOCK, OR INJURY:**

- Do not run vacuum unattended.
- Do not use to pick up flammable or combustible liquids, such as gasoline, or use in areas where they may be present.
- Do not vacuum, or use this Wet/Dry vacuum near flammable liquids, gases, or explosive vapors like gasoline or other fuels, lighter fluids, cleaners, oil-based paints, natural gas, hydrogen, or explosive dusts like coal dust, magnesium dust, grain dust, or gun powder. Sparks inside the motor can ignite flammable vapors or dust.
- To reduce the risk of health hazards from vapors or dusts, do not vacuum toxic materials.
- Do not use or store near hazardous materials.
- Do not pick up anything that is burning or smoking, such as cigarettes, matches, or hot ashes.
- Do not expose to rain. Store indoors.
- If vacuum is not working as it should, has been dropped, damaged, left outdoors, or dropped into water, return it to a service center.
- Do not unplug by pulling on cord. To unplug, grasp the plug, not the cord.
- Do not use with damaged cord or plug.
- Do not pull or carry by cord, use cord as a handle, close a door on cord, or pull cord around sharp edges or corners.
- Keep cord away from heated surfaces.
- Do not run the vacuum over cord.
- Do not handle plug or vacuum with wet hands.
- Do not use without dust bag and/or filters in place.
- Do not allow to be used as a toy. Close attention is necessary when used by or near children.

- To reduce the risk of injury from accidental starting, unplug power cord before changing or cleaning filter.
- Do not leave vacuum when plugged in. Unplug from outlet when not in use and before servicing.
- Turn off all controls before unplugging.
- Unplug before connecting or disconnecting hose, or any other accessories.
- Do not put any object into openings. Do not use with any opening blocked; keep free of dust, lint, hair, and anything that may reduce air flow.
- Keep hair, loose clothing, fingers, and all parts of body away from openings and moving parts.
- Use extra care when cleaning on stairs.
- Use only as described in this manual. Use only manufacturer's recommended attachments.
- This vacuum is provided with double insulation. Use only identical replacement parts. See DOUBLE INSULATION INSTRUCTIONS.

## SAVE THESE INSTRUCTIONS



### CAUTION

**To reduce the risk of injury from moving parts-Unplug before servicing.**



### WARNING

**To reduce the risk of electric shock-Unplug before cleaning or servicing.**

#### **When using as blower:**

- Direct air discharge only at work area.
- Do not use Wet/Dry Vacuum as a sprayer.
- Do not direct air at bystanders.
- Keep children away when blowing.
- Wear safety goggles.

## DOUBLE INSULATION INSTRUCTIONS

This Wet/Dry Vacuum is double-insulated, eliminating the need for a separate grounding system. Use only identical replacement parts. Read the instructions for Servicing Double-Insulated Wet/Dry Vacuum before servicing. Use this Wet/Dry Vacuum as described in this manual.

Observe the following warnings that appear on the motor housing of your Wet/Dry Vac.



**DOUBLE INSULATED - GROUNDING NOT REQUIRED - WHEN SERVICING USE ONLY IDENTICAL REPLACEMENT PARTS.**



### WARNING

**TO REDUCE THE RISK OF ELECTRIC SHOCK-DO NOT EXPOSE TO RAIN. STORE INDOORS.**

**FOR YOUR OWN SAFETY, READ AND UNDERSTAND OPERATOR'S MANUAL. DO NOT RUN UNATTENDED. DO NOT PICK UP HOT ASHES, COALS, TOXIC, FLAMMABLE OR OTHER HAZARDOUS MATERIALS. DO NOT USE AROUND EXPLOSIVE LIQUIDS OR VAPORS.**



### CAUTION

**DO NOT VACUUM DRYWALL DUST OR FIREPLACE SOOT OR ASH WITH STANDARD WET/DRY FILTER. THIS TYPE OF DUST IS VERY FINE WHICH MAY NOT BE CAPTURED BY THE FILTER AND CAUSE DAMAGE TO MOTOR. WHEN VACUUMING FINE DUST USE A FINE DUST FILTER (SOLD SEPARATELY).**



### WARNING

**SERVICING OF DOUBLE-INSULATED WET/DRY VACUUM**

**WITH A DOUBLE-INSULATED WET/DRY VACUUM, TWO SYSTEMS OF INSULATION ARE PROVIDED INSTEAD OF GROUNDING. NO GROUNDING MEANS IS PROVIDED ON A DOUBLE-INSULATED APPLIANCE, NOR SHOULD A MEANS FOR GROUNDING BE ADDED. SERVICING A DOUBLE**

**INSULATED WET/DRY VACUUM REQUIRES EXTREME CARE AND KNOWLEDGE OF THE SYSTEM, AND SHOULD BE DONE ONLY BY QUALIFIED SERVICE PERSONNEL. REPLACEMENT PARTS FOR A DOUBLE-INSULATED WET/DRY VACUUM MUST BE IDENTICAL TO THE PARTS THEY REPLACE. YOUR DOUBLE-INSULATED WET/DRY VAC IS MARKED WITH THE WORDS 'DOUBLE INSULATED' AND THE SYMBOL  (SQUARE WITHIN A SQUARE) MAY ALSO BE MARKED ON THE APPLIANCE.**



## **EXTENSION CORDS**

When using an extension cord with your Wet/Dry Vacuum refer to the following table to determine the required A.W.G. wire size. Before using the cleaner make sure the power cord and extension cord are in good working condition. Make repairs or replacements before using the vacuum cleaner. Only use extension cords that are rated for outdoor use.

		Length of Extension Cord			
120V		25ft (7.62m)	50ft (15.24m)	100ft(30.48m)	150ft (45.72m)
Ampere rating		A.W.G. Wire Size			
More than	Not more than				
0	6	18	16	16	14
6	10	18	16	14	12
10	12	16	16	14	12
12	16	14	12	Not recommended	

## SYMBOLS

The following signal words and meanings are intended to explain the levels of risk associated with this product.

<b>SYMBOL</b>	<b>SIGNAL</b>	<b>MEANING</b>
	<b>DANGER</b>	Indicates an imminently hazardous situation, which, if not avoided, will result in death or serious injury.
	<b>WARNING</b>	Indicates a potentially hazardous situation, which, if not avoided, could result in death or serious injury.
	<b>CAUTION</b>	Indicates a potentially hazardous situation, which, if not avoided, may result in minor or moderate injury.
	<b>NOTICE</b>	(Without Safety Alert Symbol) Indicates a situation that may result in property damage.



# UNPACKING & CHECKING CARTON CONTENTS

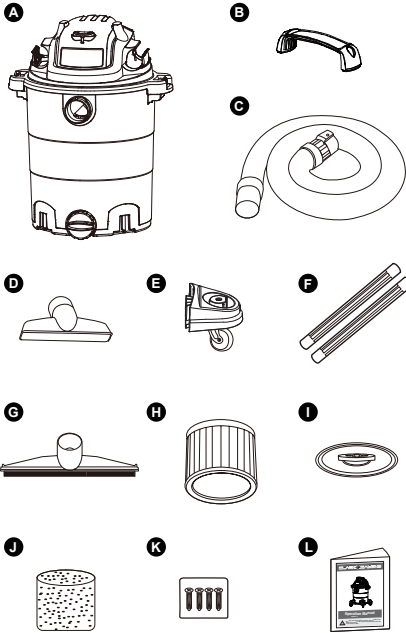

Remove all contents from the box. Remove the power head and take out any contents inside the collection tank. Check each item against the carton contents list.

## Carton Contents List:

Key	Description	Qty.
A	Vac Assembly .....	1
B	Handle .....	1
C	Hose .....	1
D	Utility Nozzle .....	1
E	Caster Foot Assembly .....	4
F	Extension Wands .....	2
G	Floor Nozzle .....	1
H	Cartridge Filter .....	1
I	Filter Retainer .....	1
J	Foam Wet Filter .....	1
K	4 Screws (Bag) .....	1
L	Operator's Manual .....	1

**NOTE:** The hose and accessories for this vacuum are 1-7/8" (3.8 cm) diameter.

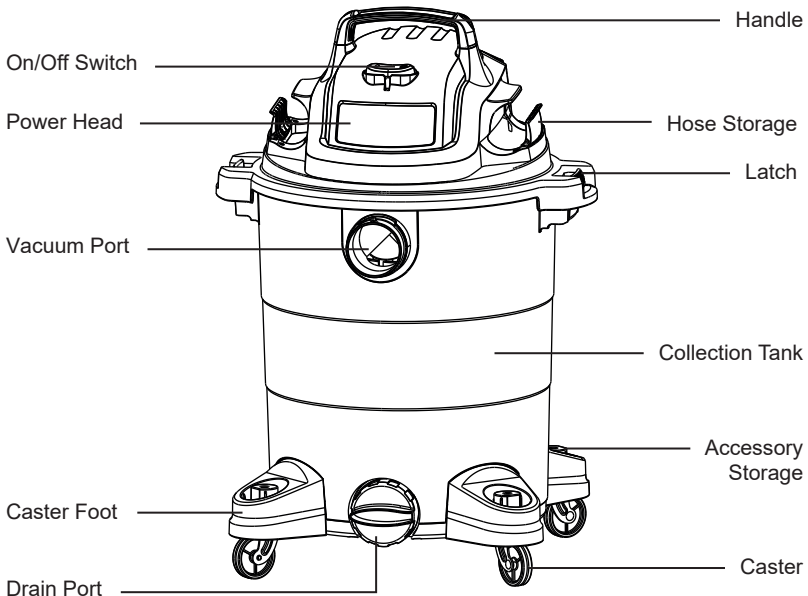

## GENERAL ASSEMBLY INSTRUCTIONS

A Philips head screw driver is required. 

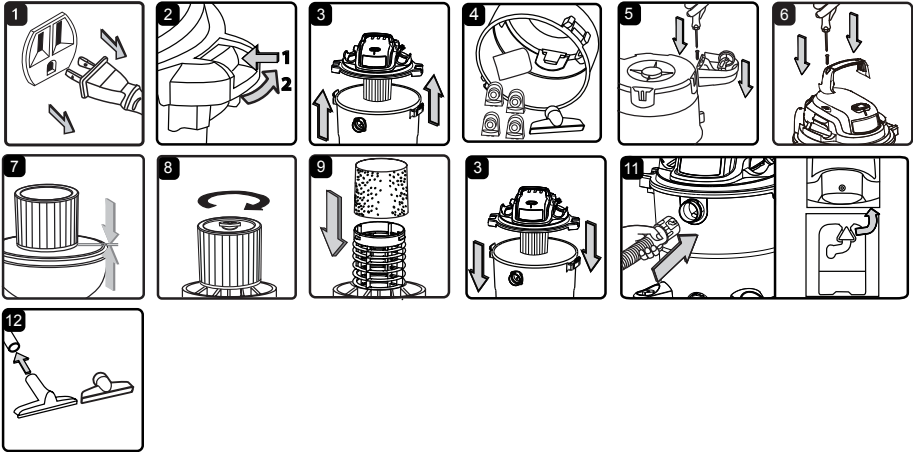

### WARNING

**DO NOT PLUG POWER CORD INTO POWER OUTLET. MAKE SURE PLUG IS DISCONNECTED BEFORE ASSEMBLING THE WET/DRY VACUUM. TO REDUCE THE RISK OF ELECTRIC SHOCK, DO NOT EXPOSE TO RAIN.**

#### UNPACKING YOUR WET/DRY VACUUM & GENERAL ASSEMBLY

1. Verify that the power cord is disconnected from the outlet (Fig. 1).
2. Undo the latches (Fig. 2).
3. Lift the power head off the collection tank (Fig. 3).
4. Remove the contents from inside the collection tank; make sure you have all contents as listed on page 9 (Fig. 4).
5. Turn the collection tank upside down and insert the four caster feet into the slots on the collection tank and tighten with supplied screws. Verify that the casters are mounted correctly. Do not over-tighten screws (Fig. 5).
6. Insert the handle into the slots located on the top of the power head and secure it with the screws provided. Do not over-tighten the screws (Fig. 6).
7. Your vacuum comes ready for dry vacuum cleaning. If the cartridge filter is not installed, refer to page 12 for installation instructions (Fig. 7 & 8).
8. For wet vacuum cleaning, remove the cartridge filter, and install the supplied foam wet filter. See page 14 for the foam wet filter installation instructions (Fig. 9).

9. Place the power head back on the collection tank aligning the top section with the latches, and snap into place (Fig. 10).
10. Insert the locking end of the hose into the vacuum port on the collection tank and lock into place (Fig. 11).
11. Choose the desired attachment and insert onto the end of the hose or extension wand (Fig. 12).

### **POLARIZED PLUG**

To reduce the risk of electrical shock, this appliance has a polarized plug (one blade wider than the other). This plug will fit in a polarized outlet only one way. If the plug does not fit fully in the outlet, reverse the plug. If it still does not fit, contact a qualified electrician to install the proper outlet. Do not change the plug in any way.  Double insulation eliminates the need for the three wire grounded power cord and grounded power supply system.

## DRY VACUUM OPERATION

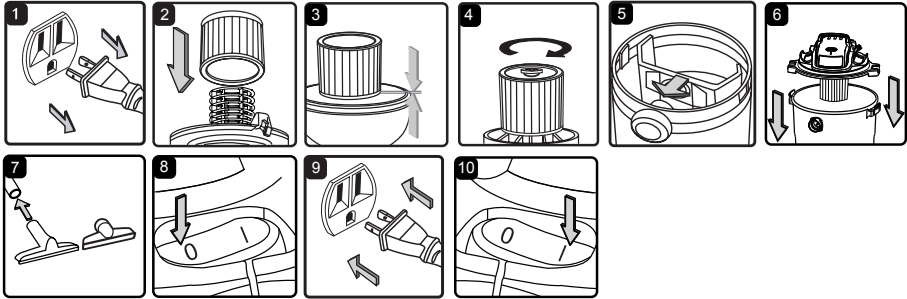

### DRY VACUUMING



### WARNING

BE SURE TO READ, UNDERSTAND, AND APPLY INFORMATION ENTITLED "IMPORTANT SAFETY INSTRUCTIONS". DO NOT VACUUM IN AREAS WITH FLAMMABLE GASES, VAPORS, OR EXPLOSIVE DUSTS IN THE AIR. FLAMMABLE GASES OR VAPORS INCLUDE BUT ARE NOT LIMITED TO: LIGHTER FLUID, SOLVENT TYPE CLEANERS, OIL-BASED PAINTS, GASOLINE, ALCOHOL, OR AEROSOL SPRAYS. EXPLOSIVE DUSTS INCLUDE BUT ARE NOT LIMITED TO: COAL, MAGNESIUM, GRAIN, OR GUN POWDER. TO REDUCE THE RISK OF HEALTH HAZARDS FROM VAPORS OR DUST, DO NOT VACUUM TOXIC MATERIALS.

DO NOT PLUG POWER CORD INTO POWER OUTLET. MAKE SURE PLUG IS DISCONNECTED BEFORE CHANGING THE FILTERS.



### CAUTION

DO NOT VACUUM DRYWALL DUST OR FIREPLACE SOOT OR ASH WITH STANDARD WET/DRY FILTER. THIS IS A VERY FINE DUST WHICH WILL NOT BE CAPTURED BY THE FILTER AND MAY CAUSE DAMAGE TO MOTOR. WHEN VACUUMING FINE DUST USE A FINE DUST FILTER (SOLD SEPARATELY).

1. Verify that the power cord is disconnected from the outlet (Fig. 1).
2. In order to prepare your vacuum for dry vacuuming, make sure the filter completely covers the filter cage against the power head. Your wet/dry vacuum comes with the cartridge filter pre-installed. For

installation instructions, see page 12 (Fig. 2 & 3).

3. Place the filter retainer on the top of the cartridge filter and tighten down by turning the retainer handle clockwise (Fig. 4).
4. Optional: For improved dust filtration, fit collection bag flange onto inlet port, taking care not to damage the bag. Dust bag sold separately (Fig. 5).
5. Place the power head back on the collection tank and secure it in place using the latches (Fig. 6).

#### **OPERATING INSTRUCTIONS: DRY VACUUMING**

6. Insert the locking end of the hose into the vacuum port on the power head and turn to lock into place.
7. Push the required attachment onto the free end of the hose or extension wand (Fig. 7).
8. Verify that the switch is in the 'O' OFF position before plugging the power cord into the power outlet. Plug the power cord into the outlet (Fig. 8 & 9).
9. Turn the motor on by flipping the switch to the 'I' ON position and begin vacuuming (Fig. 10).
10. Once you have completed vacuuming, flip the switch to the 'O' OFF position and unplug the power cord from the outlet.

**O = OFF I = ON**

**DO NOT USE THE CARTRIDGE FILTER FOR LIQUID VACUUMING.**

**DO NOT USE THE COLLECTION BAG FOR LIQUID VACUUMING.**

## LIQUID VACUUM OPERATION

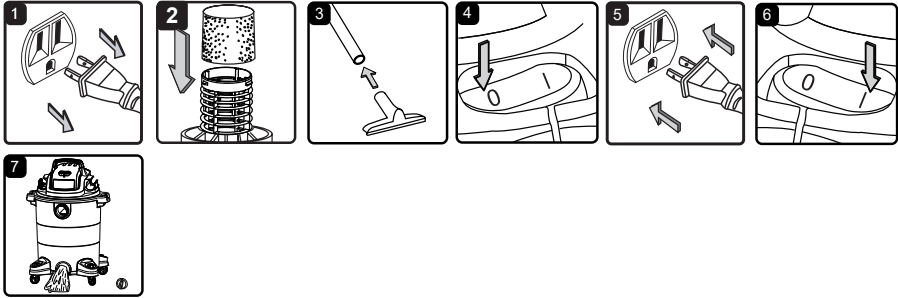

### LIQUID VACUUMING



**BE SURE TO READ, UNDERSTAND, AND APPLY INFORMATION ENTITLED "IMPORTANT SAFETY INSTRUCTIONS". DO NOT VACUUM IN AREAS WITH FLAMMABLE GASES, VAPORS, OR EXPLOSIVE DUSTS IN THE AIR. FLAMMABLE GASES OR VAPORS INCLUDE BUT ARE NOT LIMITED TO: LIGHTER FLUID, SOLVENT TYPE CLEANERS, OIL-BASED PAINTS, GASOLINE, ALCOHOL, OR AEROSOL SPRAYS. EXPLOSIVE DUSTS INCLUDE BUT ARE NOT LIMITED TO: COAL, MAGNESIUM, GRAIN, OR GUN POWDER. TO REDUCE THE RISK OF HEALTH HAZARDS FROM VAPORS OR DUST, DO NOT VACUUM TOXIC MATERIALS.**

**DO NOT PLUG POWER CORD INTO POWER OUTLET. MAKE SURE PLUG IS DISCONNECTED BEFORE CHANGING THE FILTERS.**

1. Verify that the power cord is disconnected from the outlet. Make sure that the collection tank is clean and free of dust and dirt (Fig. 1).
2. Remove the cartridge filter, then carefully install the foam wet filter over the filter cage and place the power head back on the collection tank. For foam wet filter installation instructions, see page 14 (Fig. 2).

**DO NOT USE THE CARTRIDGE FILTER FOR LIQUID VACUUMING.**

#### **OPERATING INSTRUCTIONS: WET VACUUMING**

3. Push the required attachment onto the free end of the hose or extension wand (Fig. 3).
4. Verify that the switch is in the 'O' OFF position before plugging the power cord into the power outlet. Plug the power cord into the outlet (Fig. 4 & 5).
5. Turn the motor on by flipping the switch to the 'I' ON position (Fig. 6).

6. Once you have completed vacuuming, flip the switch to the 'O' OFF position and unplug the power cord from the outlet.
7. After use, empty the collection tank by unscrewing the drain cap. Drain liquids into a suitable receptacle or drain. Remember to refit the drain cap to the collection tank (Fig. 7).

**IMPORTANT!** When vacuuming large quantities of liquids, do not immerse the nozzle completely in the liquid; leave a gap at the tip of the nozzle opening to allow air inflow. The machine is fitted with a float valve that stops the suction action when the collection tank reaches its maximum capacity. You will notice an increase in motor speed. When this happens, turn off the machine, disconnect from power supply, and drain the liquid into a suitable receptacle or drain. To continue vacuuming, refit the collection tank with the drain cap. After wet vacuuming, turn the machine off and remove plug from power supply. Empty the collection tank, clean and dry the inside and outside before storage.

**REMEMBER!** The foam wet filter must be removed after wet vacuuming, and a cartridge filter must be installed before dry vacuuming again.

## BLOWER OPERATION

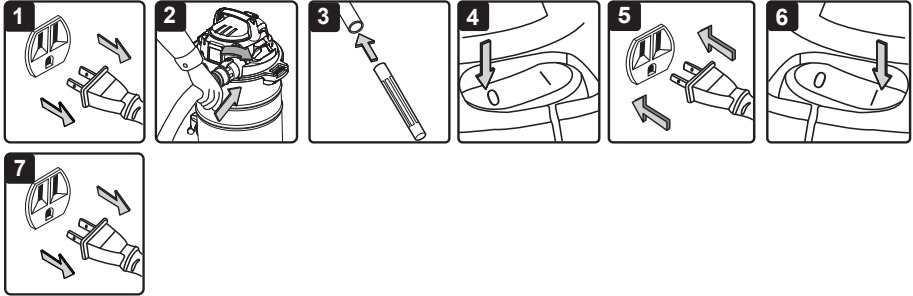

This Wet/Dry Vac has blowing capabilities. To use the blower feature follow the instructions listed.



### WARNING

**ALWAYS WEAR SAFETY GOGGLES COMPLYING WITH ANSI Z87.1 (OR IN CANADA, CSAZ94.3) BEFORE USING BLOWER.**

**KEEP BYSTANDERS CLEAR FROM BLOWING DEBRIS.**

**WEAR A DUST MASK IF BLOWING CREATES DUST THAT MIGHT BE INHALED.**

1. Verify that the power cord is disconnected from the outlet (Fig. 1).
2. Make sure the collection tank is empty before using as a blower. Clear all dirt and debris from the hose and collection tank.
3. Remove the hose from the vacuum port.
4. Secure the larger end of the hose into the blower port on the back of the power head (Fig. 2).
5. Fit the desired attachment onto the hose or extension wand (Fig. 3).
6. Verify that the power switch is in the 'O' OFF position before plugging the power cord into the outlet. Plug the power cord into the outlet (Fig. 4 & 5).
7. Before turning on the vacuum, firmly hold loose end of the hose. Turn the motor on by flipping the switch to the 'I' ON position (Fig. 6).
8. Once you have completed blowing, flip the power switch to the 'O' OFF position and unplug the power cord from the outlet (Fig. 7).



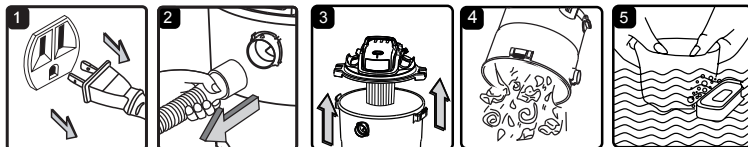

### EMPTYING THE COLLECTION TANK



### WARNING

**ALWAYS DISCONNECT THE PLUG FROM THE POWER OUTLET BEFORE REMOVING THE POWER HEAD FROM COLLECTION TANK.**

1. Verify that the power cord is disconnected from the outlet (Fig. 1).
2. Disconnect the hose from the vacuum (Fig. 2).
3. Undo the latches and remove the power head from the collection tank (Fig. 3). Place power head on a soft, clean surface upside down.
4. Clear all dirt or debris from the collection tank and hose into a proper waste container (Fig. 4).
5. Clean or replace the filters (Fig. 5).
6. Check the hose, attachments, and power cord to verify that they have not been damaged.
7. Place the power head back onto the collection tank and secure latches.

**IMPORTANT!** Clean or change the cartridge filter regularly for best performance. **ALWAYS USE CARTRIDGE FILTER FOR DRY VACUUMING.** If the machine is used without the cartridge filter, the motor will burn out and the warranty will be voided. Always keep spare filters on hand.

**NOTICE!** The filters included are made of high quality materials designed to stop small dust particles. The cartridge filter should be used for dry pick-up only. A dry cartridge filter is necessary to pick up dust. If the cartridge filter is wet, it will clog quickly and be very difficult to clean. Handle the filter carefully when removing it for cleaning and replacing it. Check the filters for tears or small holes, a small hole can let dust pass through and out of the filter. Do not use a filter with holes or tears; replace it immediately.

### STORAGE

Before storing your vacuum, the collection tank should be emptied and cleaned. The accessories should be cleaned and stored so they can be readily available when needed. Store the wet/dry vacuum indoors.

## REPAIRS

Repairs for this wet/dry vacuum should be performed only by qualified service personnel using only identical replacement parts.

## INSTALLING & CLEANING CARTRIDGE FILTER

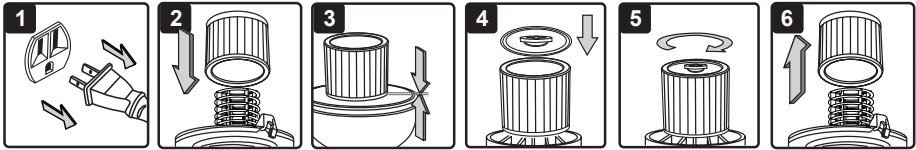

### INSTALLING CARTRIDGE FILTER

1. Verify that the power cord is disconnected from the outlet (Fig. 1).
2. Remove power head and place in upside down position.
3. Install the cartridge filter over the filter cage making sure the cage is completely covered (Fig. 2 & 3).
4. Place the filter retainer on the top of the cartridge filter over the raised lip and tighten down by turning retainer clockwise; do not over-tighten (Fig. 4 & 5).
5. Place the power head back onto the collection tank.

### REMOVING & CLEANING CARTRIDGE FILTER

1. Unlock and remove the filter retainer by turning retainer handle counter clockwise.
2. With the removed power head in an upside down position, carefully remove the cartridge filter from the filter cage (Fig. 6).
3. Clean the cartridge filter by gently tapping or brushing dirt off. Cleaning should not be done indoors in living areas. For optimal performance a new filter is recommended.
4. Install cleaned or new filters as above in steps 2-4 of Installing Cartridge Filter.
5. Allow the wet filter to air dry for 24 hours before installing onto the filter cage.

## INSTALLING & CLEANING FOAM WET FILTER

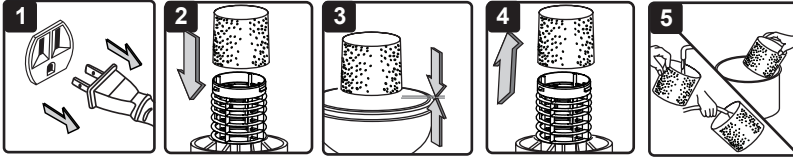

### INSTALLING FOAM WET FILTER

1. Verify that the power cord is disconnected from the outlet (Fig.1).
2. Remove power head and place in upside down position. Follow instructions to remove the cartridge filter on page 18.
3. Carefully slide the foam wet filter down over the filter cage making sure the cage is completely covered (Fig. 2 & 3).
4. Place the power head back onto the collection tank.

### CLEANING FOAM WET FILTER

1. With the removed power head in an upside down position, carefully remove the foam wet filter (Fig. 4).
2. Use a mild soap and water solution to wash the foam wet filter and rinse with clean water (Fig. 5).
3. Allow the wet filter to air dry for 24 hours before installing onto the filter cage.



## WARNING

**TO REDUCE THE RISK OF ELECTRIC SHOCK, UNPLUG BEFORE TROUBLESHOOTING.**

PROBLEM	POSSIBLE CAUSE	SOLUTION
The wet/dry vacuum will not operate.	No power supply.	Check the power supply, cord, breakers, and fuses.
	Faulty power cord.	Unplug and check the power cord. If damaged, have it repaired by a professional.
	Collection tank is full.	Empty the collection tank.
	Switch in the wrong position.	Press the ON 'I' button on the power head.
The dust comes out from the motor cover.	The cartridge filter is missing or damaged.	Attach or replace the cartridge filter.
	Vacuum has been used to collect fine dust, such as dry wall dust, fireplace soot, or ash, without a fine dust filter.	Remove the standard cartridge filter and install the appropriate fine dust filter.
Reduced efficiency and motor/speed vibration.	There is a blockage in the nozzle, hose, or the collection tank inlets. The cartridge filter is clogged by fine dust.	Check nozzle, hose and collection tank inlets for blockage. Take off the filter and clean it or install a new cartridge filter.

# EXPLODED VIEW

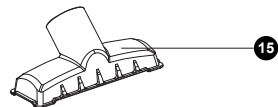
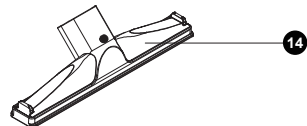
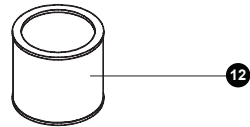
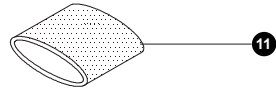
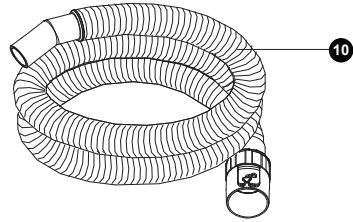
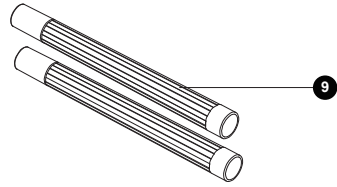
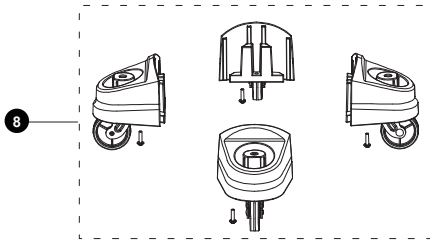
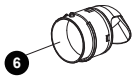
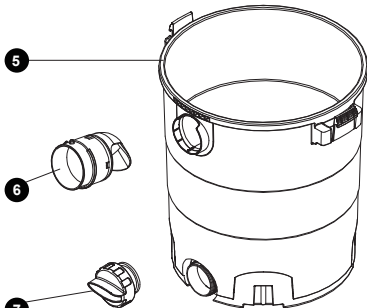
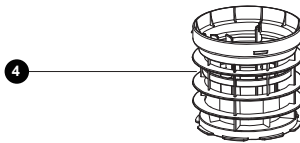
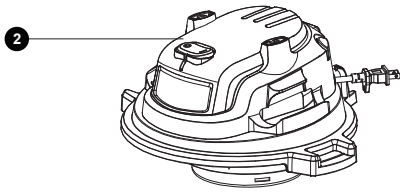

## PARTS LIST

<b>Part</b>	<b>Drawing Number</b>	<b>Description</b>	<b>Quantity</b>
1	551058101	Handle Assembly	1
2		Power Head Assembly	1
3	551416106	Float	1
4	551005104	Filter Cage	1
5		Collection Tank	1
6	551011106	Vacuum Port Assembly	1
7	551002110	Drain Cap Assembly	1
8	551058106	Caster Foot Assembly	4
9	551264103	Extension Wand	2
10	551016112	Hose	1
11	551002118	Foam Wet Filter	1
12	551030114	Cartridge Filter	1
13	551437107	Filter Retainer	1
14	551011110	Floor Nozzle	1
15	551011109	Utility Nozzle	1



For Service or Questions:  
***Call 877-806-9067***



BLACK DIAMOND™ is a trademark of Mid-States Distributing, LLC.  
© Mid-States Distributing, LLC. Manufactured for and distributed by  
Mid-States Distributing, LLC. Fort Worth, TX 76137 USA.